

# HIGH PERFORMANCE POWER AMPLIFIER

封面用157g雙銅紙，內頁用128g雙銅紙



Q 3001D

Q 5001D

Q 10001D

Q 1202

Q 2404



//Features and specifications subject to change and or improvement without notice.  
Though we tried our ensure that this manual is free and clear of errors please don't hold  
us responsible for printing errors.//

Copyright by Cadence Acoustics LTD.  
[www.cadencesound.com](http://www.cadencesound.com)

**INSTRUCTION MANUAL**

## SPECIFICATIONS

MODEL	Q 1202
Input power	11~15V DC
4 Ohm RMS Power	60Watts x 2
2 Ohm RMS Power	90Watts x 2
4 Ohm Bridged Power	130Watts x 1
Frequency Response	20Hz~36KHz
S/N Ratio	>90dB
Input Impedance	22K Ohms
Input Voltage	200mV-2V
Minimum THD	<0.05%
Adjustable Bass Boost	0/ +6 /+12dB
High Pass Crossover	50Hz-500Hz
Low Pass Crossover	50Hz-500Hz
Dimensions (L x W x H)	11.02" x 7.10" x 2.05"

MODEL	Q 2404
Input power	11~15V DC
4 Ohm RMS Power	60Watts x 4
2 Ohm RMS Power	60Watts x 2 + 90 Watts x 2
4 Ohm Bridged Power	60 Watts x 2 + 130 Watts x 1
Frequency Response	20Hz~36KHz
S/N Ratio	>90dB
Input Impedance	22K Ohms
Input Voltage	200mV-2V
Minimum THD	<0.05%
Adjustable Bass Boost	0 / +6 / +12dB
High Pass Crossover	50Hz-250Hz
Low Pass Crossover	50Hz-250Hz
Dimensions (L x W x H)	12.68" x 7.10" x 2.05"

## INTRODUCTION

Thank you for purchasing a Cadence Q series amplifier. Over the past years, the technology used to create audio amplifiers has grown by leaps and bounds, our competition is satisfied with just continuing to build the same units year after year without thought for improvement, but not us. We consider it our mission to use our expertise in developing the latest technologies and to bring you the absolute best sounding, most powerful amplifiers on the market and of course at a reasonable price. We are very proud to introduce Q Series Amplifiers. You will be amazed at the quality and power that these new amps offer. You will "Boom-Harder!" with Q series amplifiers. We have spared no expense in designing these amplifiers, creating the most rugged, reliable, powerful and best performing amplifiers.

Please read this installation guide carefully for proper use of your Cadence power amplifier. Should you need technical assistance during or after your installation please call our technical-line between 9:30 am and 5:00 PM PST at 626-465-3383. Read this entire guide fully before attempting your installation.

**WARNING: BE AWARE!** Use of this amplifier at extreme high volumes for extended periods of time may cause hearing loss and or hearing damage. During periods of prolonged high volume levels it is recommended that you use ear safety devices. Playing Cadence amplifiers at high volume levels while driving will impair your ability to hear necessary traffic sounds. While driving always keep your sound volume at reasonable levels. We at Cadence want you listening for many years to come.

When installing the amplifier, secure it tightly. An unmounted amplifier in your car can cause serious injury to passengers and damage to your vehicle if it is set in motion by an abrupt driving maneuver or short stop.

## FEATURES

Q 1202

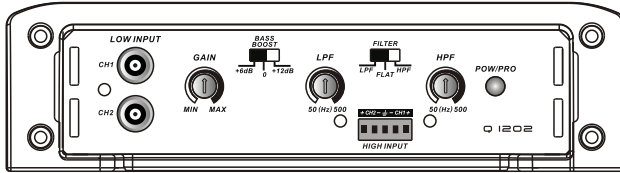

Q 2404

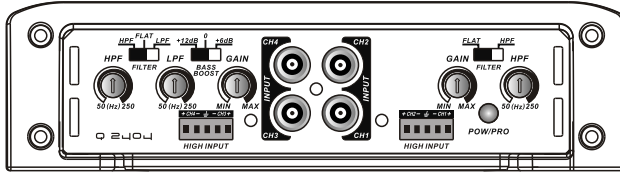

Q 3001D

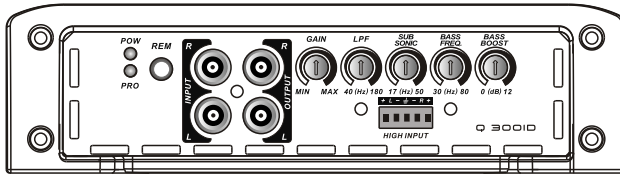

Q 5001D

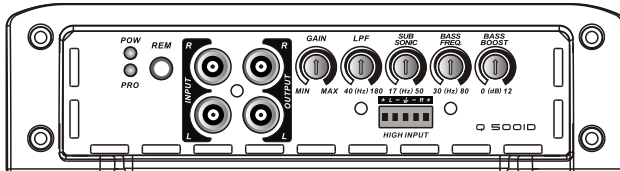

Q 10001D

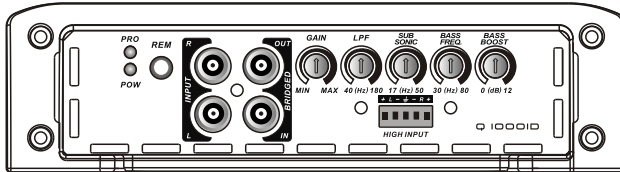

- ▾ LPF/HPF control
- ▾ Filter control
- ▾ Sub sonic control
- ▾ Mosfet power supply
- ▾ 2~8Ohm stable in stereo mode

- ▾ Gain control
- ▾ Bass Boost control
- ▾ Thermal protection
- ▾ LED Power and Protection Indicator
- ▾ Low Input and High Input Selected

## SPECIFICATIONS

### MODEL

Input power  
 Power Output RMS @ 4 Ohms  
 Power Output RMS @ 2 Ohms  
 Power Output RMS @ 1 Ohms  
 Frequency Response  
 Signal Noise Ratio  
 Input Impedance  
 Input Voltage  
 Minimum THD  
 Adjustable Bass Boost Frequency  
 Adjustable Bass Boost  
 Low Pass Crossover.  
 Adjustable Subsonic Filter  
 Dimensions (L x W x H)

### Q 3001D

11~15V DC  
 140Watts x 1  
 230Watts x 1  
 300Watts x 1  
 17Hz~180Hz  
 >90dB  
 20K Ohms  
 100mV~2.5V  
 <0.05%  
 30Hz-80Hz  
 0~12dB  
 40Hz-180Hz  
 17Hz-50Hz  
 11.90" x 7.10" x 2.05"

### MODEL

Input power  
 Power Output RMS @ 4 Ohms  
 Power Output RMS @ 2 Ohms  
 Power Output RMS @ 1 Ohms  
 Frequency Response  
 Signal Noise Ratio  
 Input Impedance  
 Input Voltage  
 Minimum THD  
 Adjustable Bass Boost Frequency  
 Adjustable Bass Boost  
 Low Pass Crossover.  
 Adjustable Subsonic Filter  
 Dimensions (L x W x H)

### Q 5001D

11~15V DC  
 200 Watts x 1  
 300 Watts x 1  
 500 Watts x 1  
 17Hz~180Hz  
 >90dB  
 20K Ohms  
 100mV~2.5V  
 <0.05%  
 30Hz-80Hz  
 0~12dB  
 40Hz-180Hz  
 17Hz-50Hz  
 13.07" x 7.10" x 2.05"

### Q 10001D

11~15V DC  
 350 Watts x 1  
 600 Watts x 1  
 1000 Watts x 1  
 17Hz~180Hz  
 >90dB  
 20K Ohms  
 100mV~2.5V  
 <0.05%  
 30Hz-80Hz  
 0~12dB  
 40Hz-180Hz  
 17Hz-50Hz  
 14.65" x 7.10" x 2.05"

## HOW TO TROUBLE SHOOT YOUR SYSTEM

**GENERAL:** A car stereo system consists of many different pieces of equipment connected together, and a logical process of elimination will find the problem area, by isolating sections, and checking them one at a time. Before following the instructions below, check and double check all wiring and connections.

**TOOLS NEEDED:** The following tools will help in finding problems:

A general purpose multimeter, capable of checking voltage and resistance, is perhaps the most useful piece of test gear that any installer can own. You may also need a test sRMSer, and a head unit, as these will be handy for temporary connection for checking purposes when you are working in the trunk of the vehicle.

**NO SOUND:** This is probably the most perplexing problem to find. First, check with your multimeter that each amplifier in the system has proper 12 volt DC supply on it's power terminals. Also check that the remote turn on terminal has 12 volt on it. If all seems well, and the amplifier power indicators light up, connect a head unit directly to the amplifier input and check for sound. If there is still nothing, connect a test sRMSer directly to the amplifier sRMSer terminal, and check for sound.

**AMPLIFIER OVERHEATING AND SHUTTING DOWN:** The most common cause for this problem is when amplifiers are overloaded with sRMSer impedances lower than what they are rated for. Double-check the impedance of your sRMSers and their wiring. Also check that no sRMSer leads are shorted to the vehicle metal chassis.

**AMPLIFIER GOING INTO PROTECTION:** When an amplifier goes into protection mode, we have to first establish whether the problem lies with the amplifier, or whether it is something in the installation. Disconnect all RCA and sRMSer cables, leaving the power, ground and remote connections. Turn the system on, and if the amplifier now powers up properly, add the RCA cables, and see if the amplifier goes into protection. If not, proceed by reconnecting the sRMSer leads, etc. By following this simple process of elimination, the fault can be diagnosed quite easily.

**LACK OF BASS:** The lack of bass can be attributed to various causes.

Check that the proper recommended enclosures have been used for the woofers.

Check the phasing of multiple woofers connected to one amplifier, as well as those connected to multiple amplifiers.

## INSTALLATION BASICS

Before you begin with your installation disconnect the NEGATIVE (-) terminal of your car's battery. This safety precaution will avoid possible short circuits while wiring your amplifier. Cadence amplifiers operate on 12-volt negative ground systems only. It is recommended that you lay out your sound system design on paper first. This will help you during the installation so that you will have wiring flowchart and not miss-wire any of your components. Mount the amplifier in the trunk or hatch area of your vehicle. Never install an amplifier in the engine compartment or on the firewall. Please be sure to leave breathing room around the amplifier heatsink so that it can dissipate the heat it produces efficiently. The amplifier can be installed either horizontally or vertically. When mounting the amplifier on the trunk floor, be sure to watch for your gas tank, gas lines, and electrical lines. Do not drill or mount any screws where they might penetrate the gas tank of your car.

### Power/ground wiring:

The Q Series amplifiers are supplied with onboard fuses, and we suggest you use an additional fuse 18" or shorter from the Battery Terminal. This fuse near the battery offers protection against damage from short circuits to the car chassis between the battery and This fused power wire should be attached to the amplifier power terminal marked 12V+. The power cable should terminate in a large ring terminal for connection directly to the positive terminal of the car battery. A second black color wire of equal gauge should be used as a ground connection to a welded chassis member. When connecting the ground wire ensure that there is no paint or other insulator blocking a good ground connection. When installing multiple amplifiers, mount them in close proximity so that they can all share the same ground point. Attach the black ground wire to the amplifier screw Terminal marked Ground. We at Cadence recommend that you use an OFC style wiring kit and we suggest never to use Copper clad Aluminum amplifier installation kit.

Over the years we have received many an amp back to our service department with melted power/ground terminals. The cause of this is a bad ground connection. When there is a lack of good ground heat builds up at the weakest point, which is the contact screw of the terminal. Over time the heat generated will begin to melt the terminal. It is a good practice to feel the power and ground wires with your hands, near their amplifier connection after having played the amp for a while. If the wires feel hot to the touch you probably have a bad or loose connection. If you are sure of your connections and the wires still feel hot to the touch, you should up-grade the gauge of the wire to next heaviest gauge.

### Remote turn on connection:

The remote turn on connection is located on the barrier strip next to the power and ground connections. This connection is responsible for turning the amplifier on and off with the rest of the system. A smaller gauge wire can be used to make this connection to your radio's power antenna lead. Should your system not have any turn on leads, you can wire the remote terminal to an accessory lead, which turns on, with your ignition.

## ADJUSTING THE SYSTEM

Once the system is operational, the first thing to do is set all crossover points to neutral settings relative to what the amp is being used for, for now, High pass: 100 Hz and Lowpass: 80Hz

Now you should set the amplifier's LEVEL adjustment. The knob accessible on the side of the amplifier marked Input Level.

To adjust the input sensitivity, turn the control using a small flat head screw driver fully counter clockwise to the 9-volt minimum position. Do not apply any pressure while turning as this might break the control unit. Adjust your radio volume level to maximum volume. Now turn the level control on the amplifier clockwise towards 200 mV marking and until audible distortion occurs. When you begin to hear any distortion in the sound back down one notch and your amp is set. It is helpful to have a second person to help you set the gain.

When setting up a multi-amp system, set each amplifier's gain separately. Start off with the bass amplifier, then adjust the highs amplifier's level control to match.

Once you're satisfied with the level control settings, use the equalizer controls to adjust the system tonal level for personal preference. Keep in mind that after equalizing, you may have to go back and reset the level controls.

**The level control of any car amplifier should not be mistaken for a volume control. It is a sophisticated device designed to match the output level of your source unit to the input level of the amplifier. Do not adjust the amplifier gain to maximum unless your input level requires it.**

If your unit has been professionally installed please do not change the gain settings set by the installer, he is the professional!

Your system can also be extremely sensitive to noise when the LEVEL is set to maximum and does not match your input signal. The gain adjustments need to be made only once when first setting up the system.

## POWER CONNECTIONS

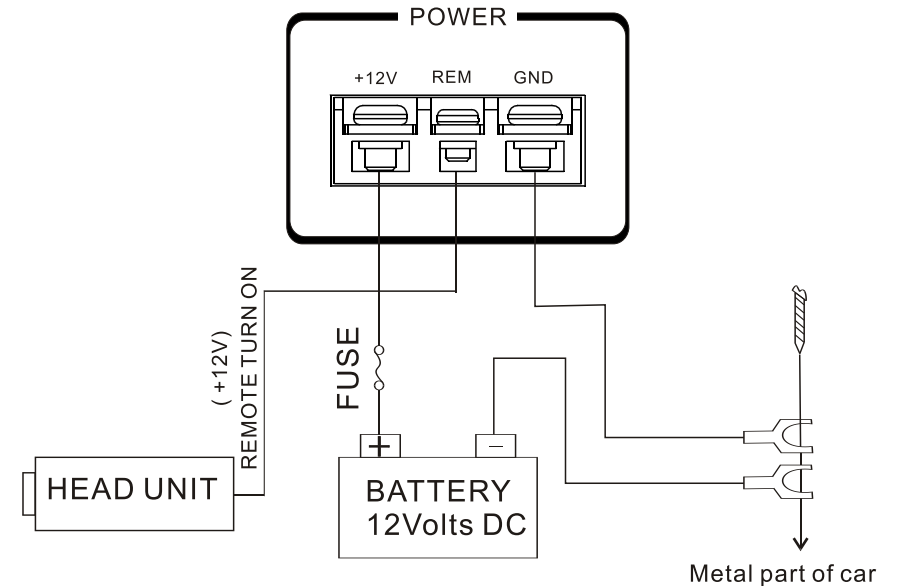

### **NOTES ON POWER AND REMOTE TURN ON CONNECTIONS**

Connect the +12V power input lead only after all other leads have been connected. Be sure to connect the ground wire of the unit securely to a metal part of the car.

### **BATTERY VOLTAGE:**

Cadence Q Series amplifiers are rated and regulated to 13.8 volts and below. Increasing voltage to 14.4 volts will increase the power output of the amplifier in the same proportion. Maximum input voltage is 15 volts while the minimum voltage is 12 volts.

### **REMOTE TURN ON CONNECTION**

The remote turn on connection is located on the barrier strip next to the power and ground connections. This connection is responsible for turning the amplifier on and off with the rest of the system. A smaller gauge wire can be used to make this connection to your radio's power antenna lead. Should your system not have any turn on leads, you can wire the remote terminal to an accessory lead, which turns on, with your ignition.

## SRMSER CONNECTIONS IN BRIDGE MODE

Q 1202

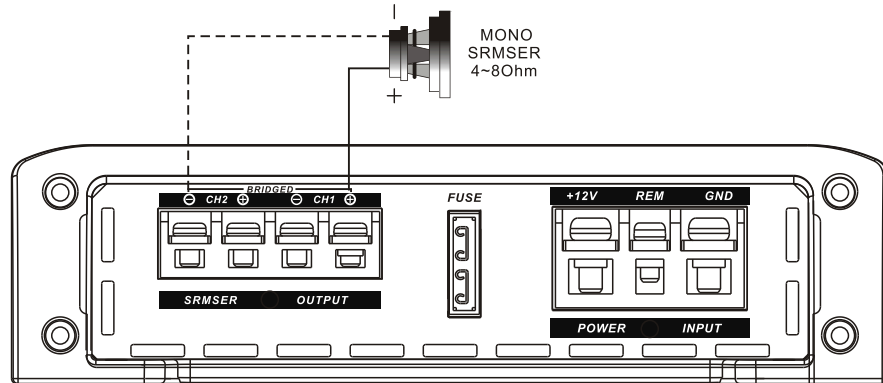

Q 2404

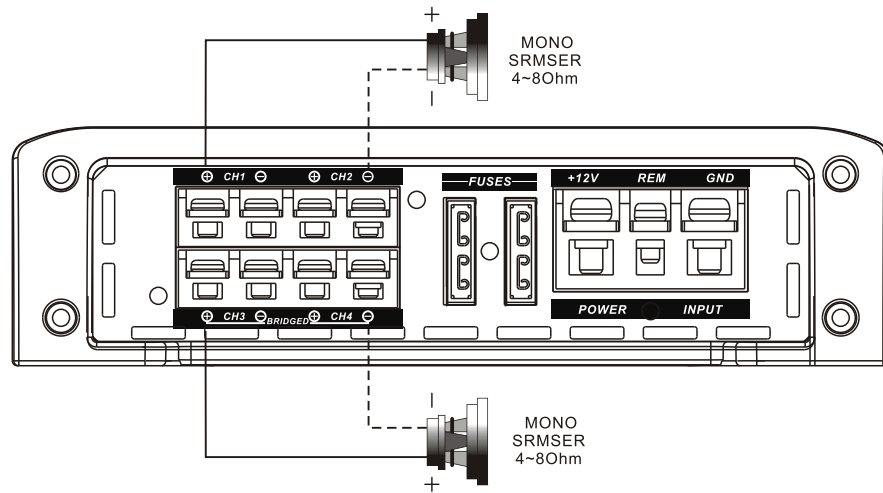

## SIGNAL CONNECTIONS

Q 3001D

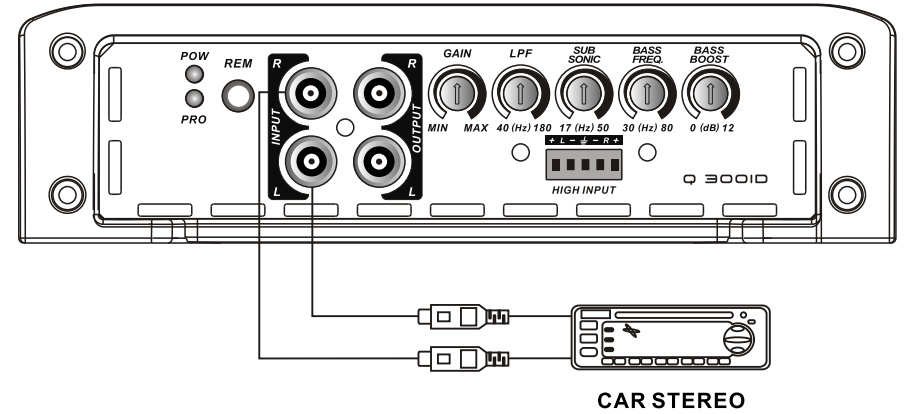

Q 5001D

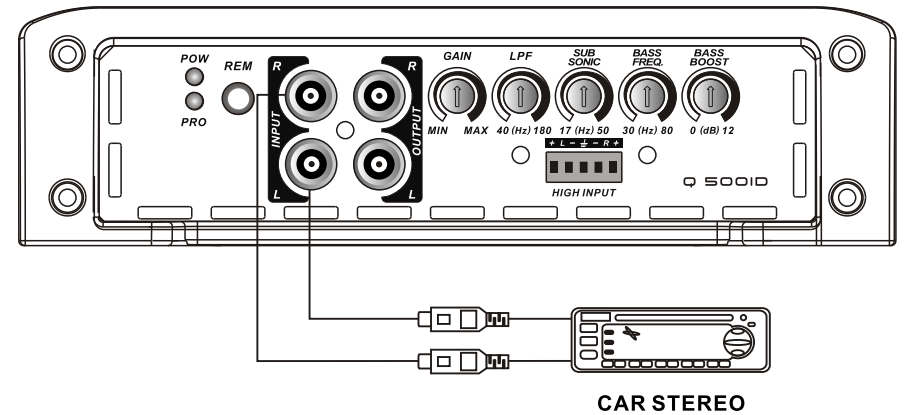

## SIGNAL CONNECTIONS

### Q 10001D

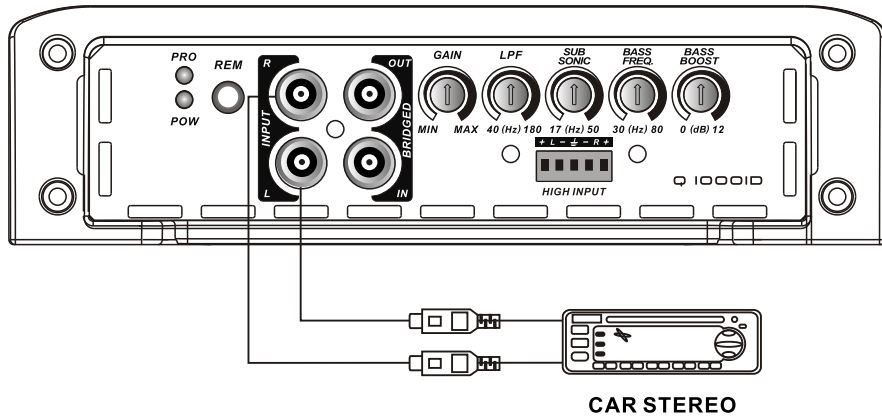

### Q 1202

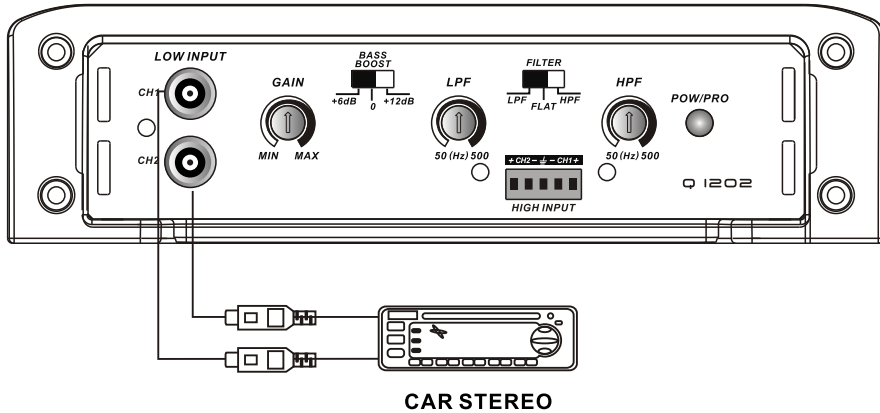

## SRMSER CONNECTIONS

### Q 1202

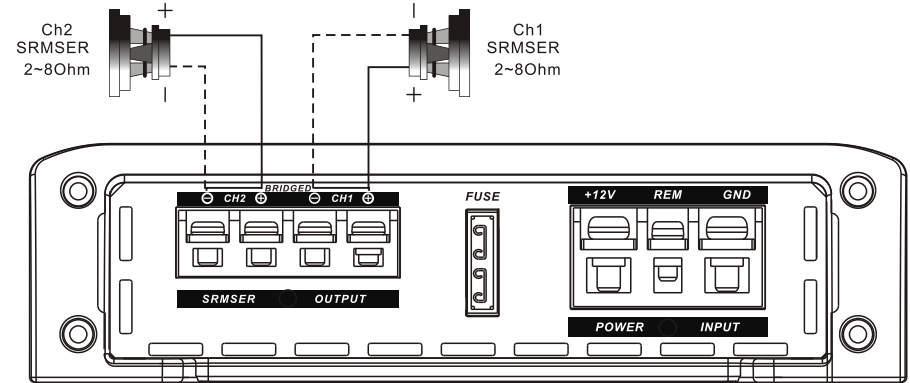

### Q 2404

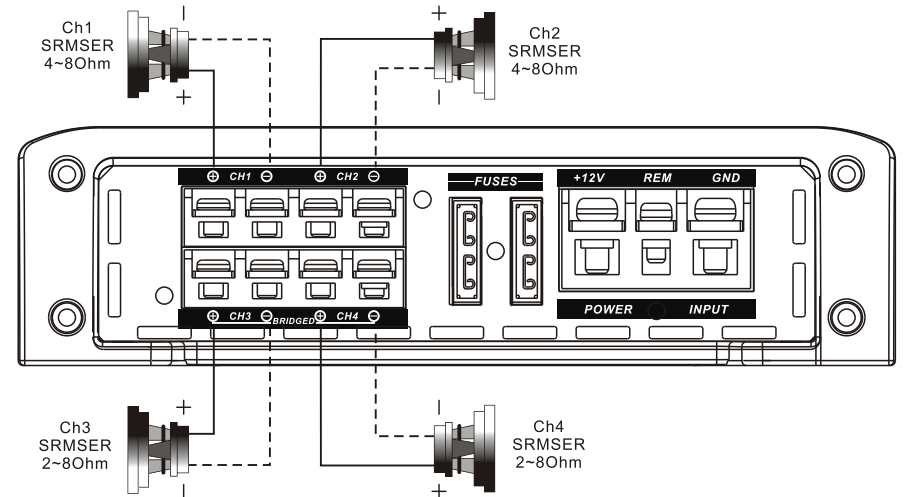

## SRMSER CONNECTIONS

### Q 3001D / Q 5001D

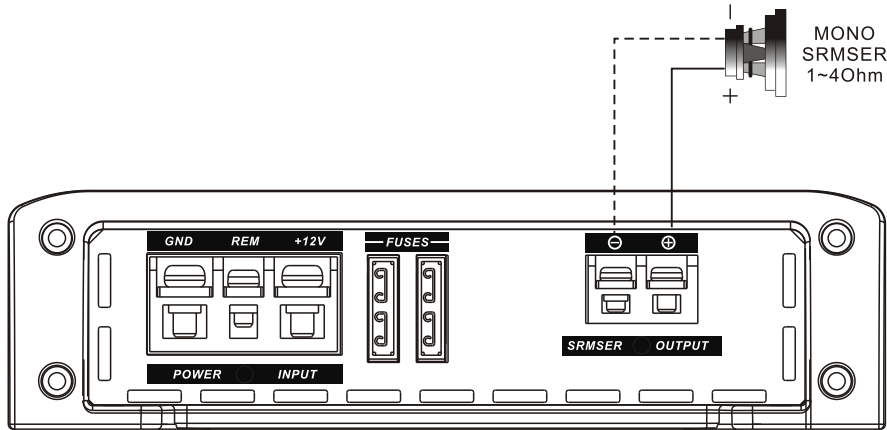

### Q 10001D

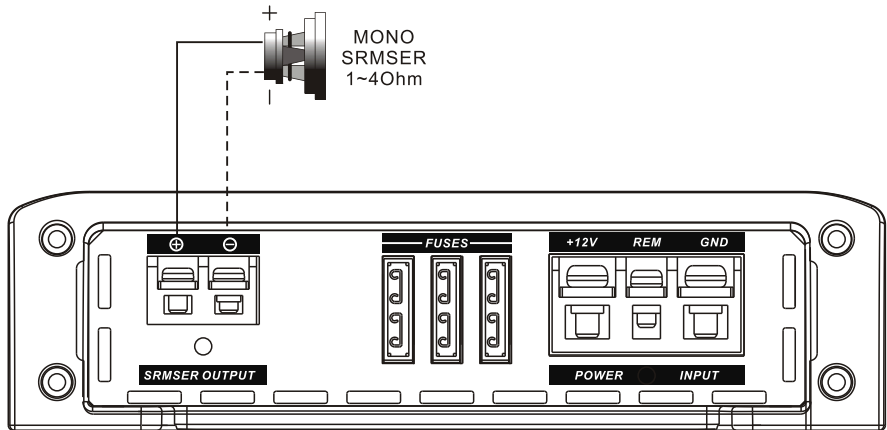

## SIGNAL CONNECTIONS

### Q 2404

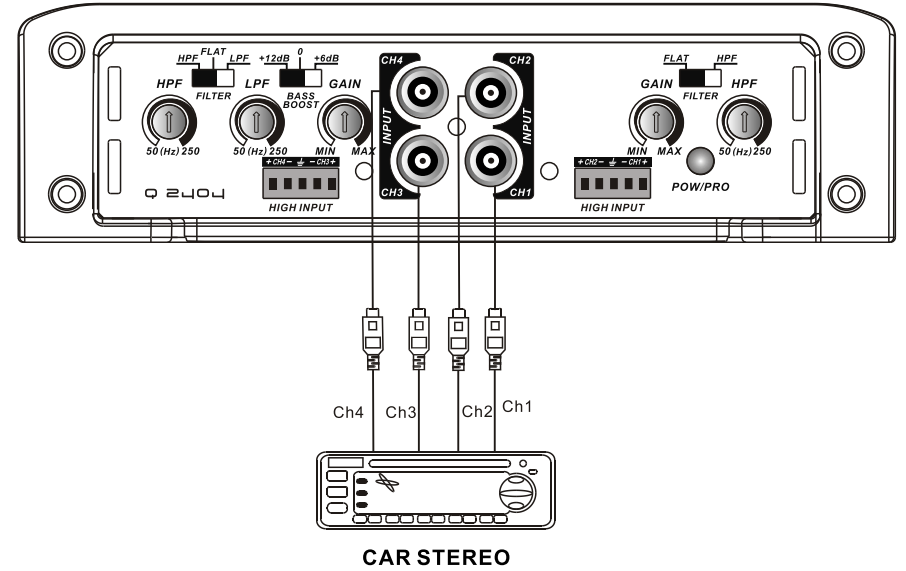

**Low level input:** These are driven by the line output of your in dash radio or intermediate signal processor, Separate Left and Right signals can be applied for Stereo or Mono operation but both inputs must be driven with the same signal for proper Bridged operation. If only mono signal is available, a "Y" adapter is required.



## CONNECTIONS OF SRMSER OUTPUT FOR BLI CONFIGURATION

### Q 10001D

AMP 1

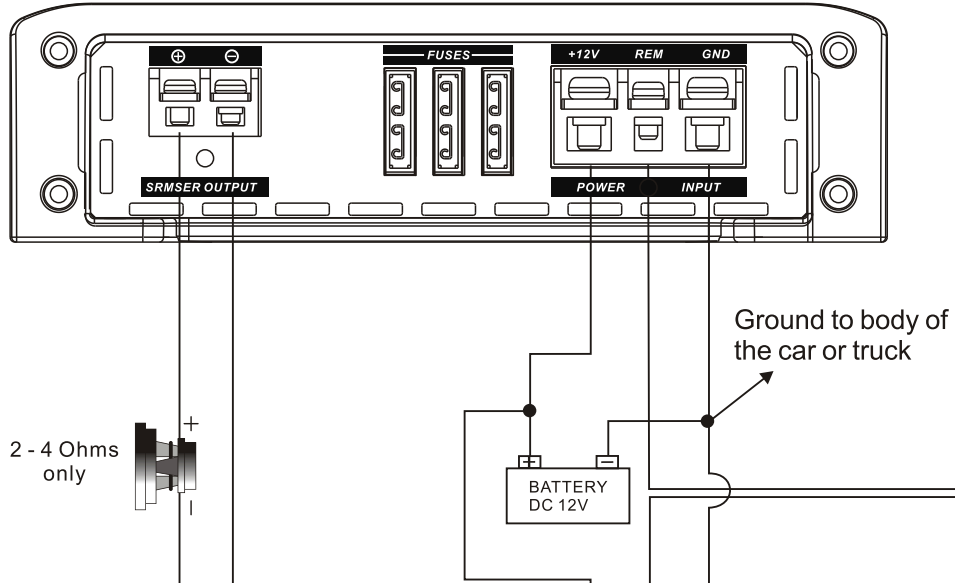

### Q 10001D

AMP 2

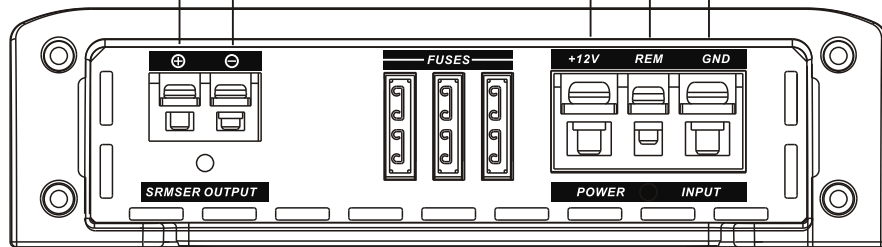

## CONNECTION OF RCA FOR BLI CONFIGURATION

### Q 10001D

AMP 1

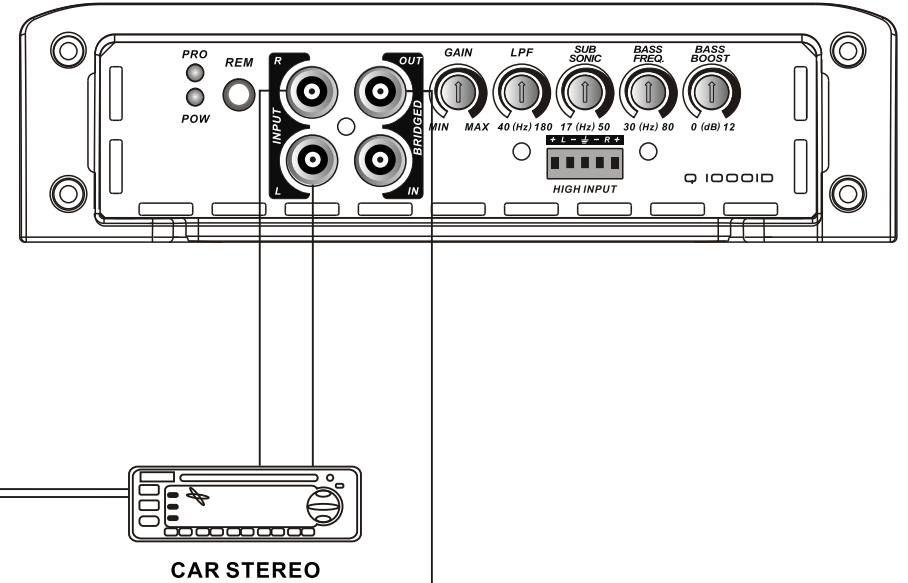

### Q 10001D

AMP 2

